

SITE CLASSIFICATION REPORT
CERTIFICATE 2553878

CLIENT EUCALYPT PROPERTY PTY LTD
JOB ADDRESS LOT 225 GINGHAM WAY BRABHAM
CLIENT JOB NO.
OWNER
STRUCTERRE JOB NO. S926908
DATE OF ASSESSMENT 16/7/19

SITE RECORD



SITE CLASSIFICATION	A	<i>(in accordance with AS2870)</i>
FOOTING DETAIL	D10	
SAND PAD	No sand pad required structurally	
BUSHFIRE PRONE AREA	Yes	<i>(see NOTE 2.)</i>
CORROSION CLASSIFICATION	R1	<i>(Durability Class in accordance with AS3700)</i>
WIND CLASSIFICATION	N1	<i>(in accordance with AS4055)</i>
-TERRAIN CATEGORY	3	
-TOPOGRAPHIC	T0	
-SHIELDING	Full Shielding	

WA | QLD | NSW | VIC

1 Erindale Road, Balcatta, Western Australia 6021 | PO Box 792, Balcatta, Western Australia 6914
 Phone (+618) 9205 4500 | Fax (+618) 9205 4501 | Email wageotechsite@structerre.com.au | Web www.structerre.com.au
 ABN 71 349 772 837 Zemla Pty Ltd ACN 008 966 283 as trustee for the Young Purich and Higham Unit Trust trading as Structerre Consulting Engineers

SOIL PROFILE

BOREHOLE 1: 0 - 1000 FILL - sand - grey / brown; 1000 - 2000 FILL - sand - yellow / brown; 2000 - 2500 SAND - pale brown; 2500 end of hole.

NOTES

NOTE 1 Explanatory Notes & Standard Recommendations

This site classification report must be read in conjunction with the applicable Explanatory Notes & Standard Recommendations. For A Class sites, refer to the Explanatory Notes and Standard Recommendations for Stable (A Class) Sites, version 1.0 July 2018. For S, M, H1, H2 & E Class sites, refer to the Explanatory Notes and Standard Recommendations for Reactive (S, M, H1, H2 & E Class) Sites version 1.0 July 2018. For Equivalent Class sites, refer to the Explanatory Notes and Standard Recommendations for Equivalent Class Sites, version 1.0 July 2018.

NOTE 2 Bushfire - Prone Area

The Site may be situated in a bush fire prone area in accordance with the Department of Fire and Emergency Services (DFES) Bushfire Prone Area Map (Reference: <http://www.dfes.wa.gov.au/regulationandcompliance/bushfireproneareas/>) the current version at the time of this assessment. A Bushfire Attack Level (BAL) assessment may be required for this site, please confirm with the local authority. Should you require an assessment, please contact this Office.

ADDITIONAL NOTES / REQUIREMENTS

Site Condition

At the time of inspection the site was considered to be level and cleared. For specific levels of this site or topographical features, please refer to a professional site survey.



EXTERNAL WALLS

NOTE:
 WHERE TERMI MESH IS USED THE DEPTH OF EMBEDMENT IS TO BE:
 - AT DOORS AND FULL HEIGHT WINDOWS WITH PAVING OUTSIDE = 200mm
 - AT FULL HEIGHT WINDOWS AND OTHER LOCATIONS WHERE SOIL OUTSIDE = 230mm
 - THESE DEPTHS SATISFY TERMI MESH REQUIREMENTS

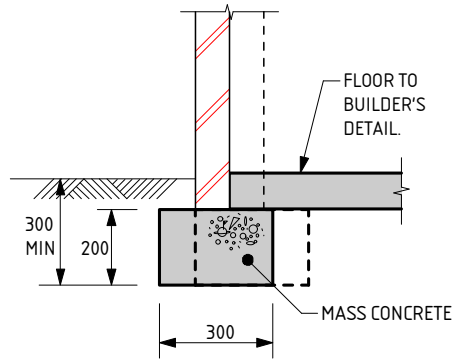

GARAGE WALL

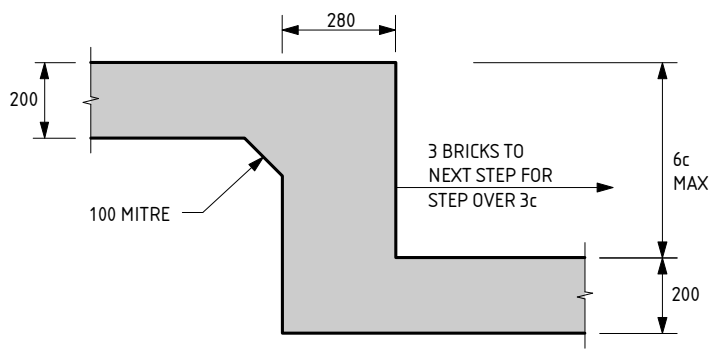

FOOTING STEP

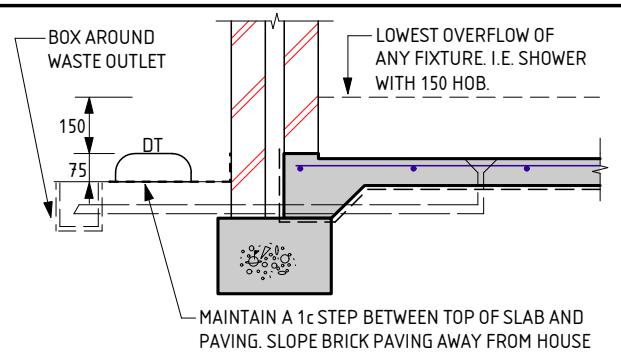

EXTERNAL WALLS AT WET AREAS

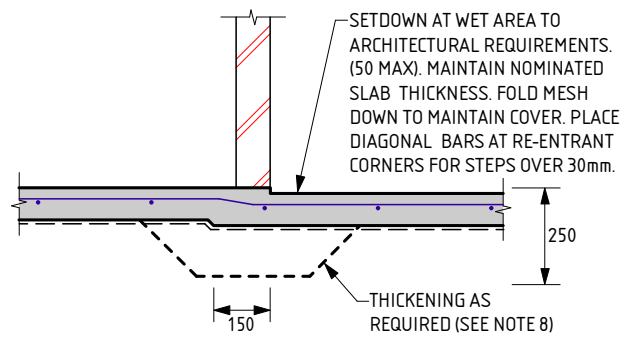

WET AREA STEP



SERVICE PIPE DIAGRAM

- MINIMUM HORIZONTAL DISTANCE BETWEEN 2 PENETRATIONS TO BE 2 x DIAMETER OF THE LARGER PIPE.
 - MAXIMUM PENETRATION SIZE TO BE Ø150.

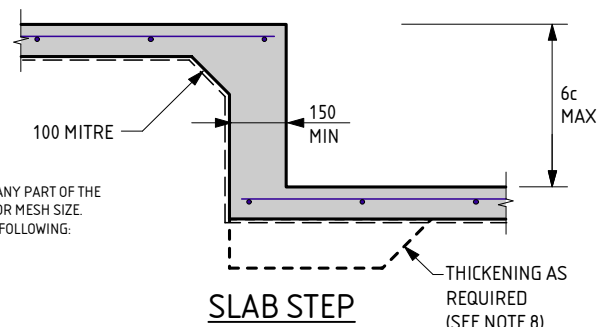

SLAB STEP

D10 FOOTING NOTES:

1. REMOVE ALL TOPSOIL, VEGETATION AND DELETERIOUS FILL MATERIAL FROM THE BUILDING AREA.
2. SAND FILL TO BE CLEAN WELL DRAINED, WITH MAX FINES (PARTICLES UP TO 0.07mm) CONTENT OF 5%. SAND TO BE COMPACTED TO A MIN 6 BLOWS/300mm FOR 750mm OR DEPTH OF PAD.
3. A MIN OF 150mm OF SAND REQUIRED UNDER FOOTINGS.
4. IF CLAY ON SITE AN ENGINEER TO BE CONSULTED.
5. ROOF AND SURFACE WATER TO BE TAKEN AWAY FROM FOUNDATION AREA.
6. EXCAVATIONS FOR PLUMBING NOT TO UNDERMINE FOOTINGS. IF UNDERMINING IS LIKELY TO OCCUR, CONTACT THE ENGINEER.
7. PIERCING THE VAPOUR BARRIER (VPM) USING LEVELLING PINS ON FREE DRAINING SAND PADS WILL STILL ENABLE THE BARRIER TO MEET THE PERFORMANCE PROVISIONS OF THE BUILDING CODE OF AUSTRALIA.
8. PLACE SLAB THICKENINGS (300 WIDE x 250 DEEP) UNDER INTERNAL WALLS (90 OR 110) HIGHER THAN 3.7m.
9. CONCRETE TO CONFORM WITH AS 3600.
10. BLENDED CEMENT TO CONFORM WITH AS 3972.
11. ALL CONCRETE TO BE N20/20/100.
12. REINFORCEMENT SHALL BE IN ACCORDANCE WITH THE FOLLOWING STANDARDS;
 SL INDICATES DEFORMED SQUARE MESH D500L TO AS/NZS 4671.
 ALL STEELWORK TO BE TREATED IN ACCORDANCE WITH THE NATIONAL CONSTRUCTION CODE OR TO AS 3700, AS APPLICABLE.
13. IF POLISHED (OR HONED) CONCRETE FINISHES ARE DESIRED, THIS DESIGN SHOULD BE REFERRED BACK TO THIS OFFICE FOR CONSIDERATION, AS IT IS NOT THE INTENTION OF THESE DESIGNS FOR SUCH FINISHES.

14. IF THE LENGTH TO WIDTH RATIO OF THE GROUND SLAB OR ANY PART OF THE GROUND SLAB EXCEEDS 3:1. REFER BACK TO THIS OFFICE FOR MESH SIZE. IF THE LENGTH TO WIDTH RATIO IS LESS THAN 3:1 USE THE FOLLOWING:
 USE SL53 MESH FOR SLAB SPAN UP TO 22m.
 USE SL52/SL63 MESH FOR SLAB SPAN UP TO 26m.
 USE SL62 MESH FOR SLAB SPAN UP TO 28m.
 USE SL72 MESH FOR SLAB SPAN UP TO 32m.
 30 TOP COVER TO REINFORCEMENT.
15. CURE SLAB AS DETERMINED BY ENGINEER.
16. THIS FOOTING DETAIL HAS BEEN DESIGNED WITHIN THE PARAMETERS OF "AS2870 RESIDENTIAL SLABS AND FOOTINGS -CONSTRUCTION".
17. MAXIMUM HEIGHT OF CAVITY WALL TO BE 2750mm ABOVE FLOOR LEVEL.
18. THIS IS A PERFORMANCE-BASED DESIGN.
19. A BRICK COURSE, AS REFERRED TO IN THIS DOCUMENT IS STANDARD 86mm HIGH.
20. LAP ALL MESH ONE TRANSVERSE WIRE PLUS 25mm OR TO MANUFACTURER'S SPECIFICATIONS.
21. THE SLAB DESIGN IS CONSIDERED SUITABLE AS A PHYSICAL BARRIER AGAINST INGRESS OF TERMITES.

QUALITY CONTROL PROGRAM REQUIREMENTS

1. SLAB DEPTH IS TO BE CONFIRMED BY STRUCTERRE ON SITE.

THE APPROVED SIGNATURE ON THIS FOOTING AND SLAB DETAIL ENDORSES ITS USE FOR SINGLE STOREY BUILDINGS ON CLASS A STABLE SITES.

D10



Zemia Pty. Ltd. (ABN: 71 349 772 837) ATF the Young Purich and Higham
 Unil Trust Trading as Structure Consulting Engineers
 1 ERINDALE ROAD, BALCATTA W.A. 6021
 TEL (08) 9205 4500 FAX (08) 9205 4541 EMAIL: perth@strucrerre.com.au

PROJECT : LOT 225 GINGHAM WAY BRABHAM	
CLIENT : EUCALYPT PROPERTY PTY LTD	
SCALE : 1:20	APPROVED
DATE : 16/7/19	

EXPLANATORY NOTES AND STANDARD RECOMMENDATIONS – STABLE (A CLASS) SITES (Sheet 1 of 2)

GENERAL

1. THE EXPLANATORY NOTES AND THE STANDARD RECOMMENDATIONS ARE TO BE READ IN CONJUNCTION WITH THE SITE CLASSIFICATION REPORT.
2. ALL REFERRED STANDARDS TO BE THE CURRENT VERSION AT THE TIME OF THE CONSTRUCTION.
3. THE PURPOSE OF THE SITE CLASSIFICATION REPORT IS TO CLASSIFY THE SITE IN ACCORDANCE WITH AS2870 "RESIDENTIAL SLABS AND FOOTING". IT IS NOT INTENDED FOR ANY OTHER PURPOSE, INCLUDING SOLE INFORMATION IN THE PROVISION OF A QUOTATION FOR SITE WORKS BY EARTH WORKERS. IT IS RECOMMENDED EARTH WORKERS PERFORM THEIR OWN INVESTIGATION FOR QUOTATION PURPOSES.
4. THE SITE CLASSIFICATION REPORT WILL INCLUDE BUT IS NOT LIMITED TO:
 - a) THE SITE CLASSIFICATION IN ACCORDANCE WITH AS2870 RESIDENTIAL SLABS AND FOOTING CONSTRUCTION,
 - b) A WIND RATING IN ACCORDANCE WITH AS 4055 WIND LOADS FOR HOUSING,
 - c) A COASTAL CORROSION CLASSIFICATION,
 - d) ADDITIONAL EARTHWORK RECOMMENDATION WHERE APPLICABLE,
 - e) STANDARD FOOTING DESIGN FOR SINGLE STOREY SLAB ON GROUND CONDITIONS.
5. THE SITE CLASSIFICATION REPORT IS BASED ON THE SITE AS PRESENTED AT THE TIME OF ASSESSMENT. IF FURTHER INFORMATION RELATING TO THE SITE OR DEVELOPMENT BECOMES AVAILABLE, THESE RECOMMENDATIONS ARE SUBJECT TO CHANGE.
6. CLASS A SITES ARE STABLE SITES, GENERALLY SAND, LIMESTONE, GRAVEL OR A COMBINATION. CLASS P ARE PARTICULAR CLASSIFICATIONS SUCH AN UNUSUAL SITES OR SITES REQUIRING ADDITIONAL INVESTIGATION PRIOR TO PROVIDING DETAILS.
7. BOREHOLES EXCAVATED REVEAL THE SOIL PROFILE AT THE BOREHOLE LOCATION ONLY. FROM THIS, IT IS INFERRED THAT THESE ARE THE SOIL CONDITION OVER THE SITE. VARIATIONS CAN OCCUR WHICH MAY NOT HAVE BEEN DETECTED AT THE INVESTIGATION STAGE. ANY ANOMALIES SHOULD BE REFERRED BACK TO THIS OFFICE FOR REASSESSMENT.
8. A NUMBER OF BOREHOLES ARE CONDUCTED ACROSS THE SITE IN ORDER TO DETERMINE THE SOIL PROFILES AND PROVIDE A REPRESENTATION OF THE GROUND CONDITIONS.

SAND PAD

9. THE RECOMMENDED FOOTING DESIGN IS ONLY TO BE USED IN CONJUNCTION WITH THE RECOMMENDED SAND PAD AND EARTHWORKS AS OUTLINED IN THE SITE CLASSIFICATION REPORT.
10. THE RECOMMENDATIONS FOR THE SAND PAD IS FOR STRUCTURAL PURPOSES ONLY, AND DOES NOT PROVIDE THE MINIMUM FINISHED PAD LEVEL IN RELATION TO FLOOD LEVELS, OR DEPTH TO GROUNDWATER. SHOULD THE TEST BE LOCATED IN A LOW LYING OR FLOOD PRONE AREA, REFER TO THE LOCAL AUTHORITY FOR MINIMUM BUILDING HEIGHT.
11. IMPORTED FILL FOR USE AS A SAND PAD TO BE IN ACCORDANCE TO AS 3798 "GUIDELINES ON EARTHWORKS FOR COMMERCIAL AND RESIDENTIAL DEVELOPMENTS" WHICH INCLUDES BUT IS NOT LIMITED TO: BE FREE FROM ANY DELETERIOUS MATERIALS INCLUDING ORGANICS, (ROOTS, STUMPS, GRASSES, DECOMPOSED ORGANICS – PEAT, TIMBER, ETC), BUILDING RUBBLE, GLASS, PLASTICS OR WASTE MATERIAL. THE FINES CONTENT, (PERCENTAGE PASSING THE 0.075mm SIEVE) TO BE LESS THAN 5% BY MASS.
12. ON CLASS A SITES, A SAND PAD IS NOT REQUIRED STRUCTURALLY, HOWEVER IF ROCK IS ENCOUNTERED, A MINIMUM 450mm SAND PAD BEYOND THE BASE OF FOOTING IS RECOMMENDED.
13. SAND PAD TO EXTEND BEYOND BUILDING AREA A MINIMUM OF 1.5 TIMES THE PAD DEPTH. RECOMMENDED SAND PAD DEPTH IS ABOVE THE HIGHEST POINT, UNLESS OTHERWISE SPECIFIED.
14. IT IS REQUIRED THAT EARTHWORKS CONFIRM THAT THE MINIMUM DEPTH OF RECOMMENDED SAND PAD IS ACHIEVED.

EARTHWORKS

15. RECOMMENDED EARTHWORKS TO BE CONDUCTED IN ACCORDANCE WITH AS3798 "GUIDELINES ON EARTHWORKS FOR COMMERCIAL AND RESIDENTIAL DEVELOPMENTS", AND TO INCLUDE BUT NOT BE LIMITED TO:
 - a. REMOVAL OF ALL VEGETATION, TOPSOILS, UNCONTROLLED FILLS AND OTHER DELETERIOUS MATERIALS FROM THE BUILDING AREA,
 - b. GRUBBING OUT OF ANY TREES ENSURING THE REMAINING HOLES ARE BACKFILLED WITH CLEAN COMPACTED SAND,
 - c. NOTIFYING THE ENGINEER OF ANY UNUSUAL FEATURE OR DISCREPANCY THAT MAY BECOME EVIDENT DURING EARTHWORKS, PRIOR TO PROCEEDING,
 - d. COMPACTING TO MEET THE REQUIREMENTS AS OUTLINED IN AS 3798 TABLE 5.1.
16. FILL MATERIAL (WHICH IS NOT ALWAYS APPARENT AT THE INITIAL INVESTIGATION STAGE) IS TO BE DEALT WITH AS FOLLOWS:
 - a. IF IT IS CERTIFIED BY OTHERS IT CAN REMAIN.
 - b. IF IT IS NOT CERTIFIED WILL REQUIRE REMOVAL DOWN TO NATURAL GROUND OR VERIFIED. ANY SAND CAN BE REUSED.
 - c. IF A PAD HAS ALREADY BEEN CONSTRUCTED, THE SITE CLASSIFICATION IS NOT CERTIFICATION OF THE PAD. CONTACT THIS OFFICE SHOULD A SAND PAD CERTIFICATION BE REQUIRED.
17. ANY ORGANIC MATTER OR ROOTS ENCOUNTERED, WHICH IS BEYOND WHAT IS NORMALLY CONSIDERED ACCEPTABLE IS TO BE REMOVED. THIS WILL NECESSITATE RAKING THE SITE TO REMOVE ORGANIC MATERIAL, TURNING THE SITE OVER AND RE- COMPACTING TO A MINIMUM.

RETAINING WALLS

18. AN ASSESSMENT OF ANY EXISTING OR PROPOSED RETAINING WALLS HAS NOT BEEN CONDUCTED AS PART OF THIS SITE CLASSIFICATION REPORT.
19. IF THE PROPOSED BUILDING IS TO BE LOCATED CLOSER TO THE RETAINING WALL THAN THE HEIGHT OF THE RETAINING WALL, THIS MAY PLACE ADDITIONAL LOADS ON THE WALL THAT WERE NOT INITIALLY DESIGNED FOR. AN INSPECTION OF THE STRUCTURAL INTEGRITY OF THE RETAINING WALL WILL BE REQUIRED TO PROVIDE CERTIFICATION AND/OR RECOMMENDATIONS PRIOR TO ANY CONSTRUCTION. PLEASE REFER BACK TO THIS OFFICE FOR ASSISTANCE.

STORMWATER DRAINAGE

20. ALL SOAKWELLS ARE TO BE LOCATED THE DEPTH OF SOAKWELL AWAY FROM THE BUILDING AND SETBACK MINIMUM OF 1200mm, WHICHEVER IS GREATER. PLEASE REFER BACK TO THIS OFFICE IF REQUIRED THE SET-BACK CANNOT BE ACHIEVED.

DOC# SS001 - 1.1.3 V1.0 - JULY 2018



Zemla Pty. Ltd. (ABN: 71 349 772 837) ATF the Young Purich and Higham
Unit Trust trading as StrucTerre Consulting Engineers
1 ERINDALE ROAD, BALCATTA W.A. 6021
TEL (08) 9205 4500 FAX (08) 9205 4541 EMAIL: perth@strucTerre.com.au

PROJECT:

LOT 225 GINGHAM WAY BRABHAM

CLIENT:

EUCALYPT PROPERTY PTY LTD

SCALE

1:20

APPROVED

DATE

16/7/19

EXPLANATORY NOTES AND STANDARD RECOMMENDATIONS – STABLE (A CLASS) SITES (Sheet 2 of 2)

WIND CLASSIFICATION

21. WIND CLASSIFICATION IS GIVEN FOR THE EXPECTED CONDITION 5 YEARS HENCE. THIS CLASSIFICATION IS LIMITED TO BUILDINGS CLASSES 1 AND 10, WHICH HAVE THE FOLLOWING LIMITATION (AS PER AS4055):
- MAXIMUM DISTANCE FROM THE GROUND LEVEL TO THE UNDERSIDE OF EAVES SHALL NOT EXCEED 6.0m.
 - MAXIMUM DISTANCE FROM GROUND LEVEL TO THE HIGHEST POINT OF THE ROOF, EXCLUDING CHIMNEYS, SHALL NOT EXCEED 8.5m.
 - THE ROOF PITCH SHALL NOT EXCEED 35 °.
 - THE WIDTH, EXCLUDING EAVES, SHALL NOT EXCEED 16.0m AND THE LENGTH SHALL NOT EXCEED 5x THE WIDTH.
- IF THE BUILDING FALLS OUTSIDE OF THESE LIMITATIONS, THE STATED WIND CLASSIFICATION DOES NOT APPLY. REFER BACK TO THIS OFFICE FOR A REVISED WIND CLASSIFICATION.

ENVIRONMENTAL

22. NO ENVIRONMENTAL ASSESSMENT OF THIS SITE HAS BEEN UNDERTAKEN. SHOULD AN ENVIRONMENTAL ASSESSMENT BE REQUIRED, IT IS RECOMMENDED THAT AN ENVIRONMENTAL ENGINEER BE ENGAGED.

SEISMIC

23. RECOMMENDED FOOTING DETAILS ARE SUITABLE FOR SEISMIC CONDITIONS WITH AN EARTHQUAKE HAZARD FACTOR OF ≤ 0.11 . RECOMMENDED FOOTING DETAILS PROVIDED FOR SITES WITH AN EARTHQUAKE HAZARD FACTOR OF > 0.11 , ARE NOT FOR CONSTRUCTION, BUT FOR COSTING PURPOSES ONLY. IT IS RECOMMENDED REQUIRED THAT A FULL SEISMIC DESIGN IS CONDUCTED.

CORROSION CLASSIFICATION

24. THE CORROSION CLASSIFICATION HAS BEEN ASSESSED IN ACCORDANCE WITH AS3700.

DOC# SS001 - 1.1.3 V1.0 - JULY 2018

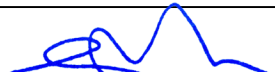

Zemla Pty. Ltd. (ABN: 71 349 772 837) ATF the Young Purich and Higham
Unit Trust trading as Structerre Consulting Engineers
1 ERINDALE ROAD, BALCATTIA W.A. 6021
TEL (08) 9205 4500 FAX (08) 9205 4541 EMAIL: perth@structerre.com.au

PROJECT : LOT 225 GINGHAM WAY BRABHAM	
CLIENT : EUCALYPT PROPERTY PTY LTD	
SCALE 1:20	APPROVED 
DATE 16/7/19	